

Configuration options

0463-595-7010; 0463-595-7012; 0463-595-7013

STIHL®

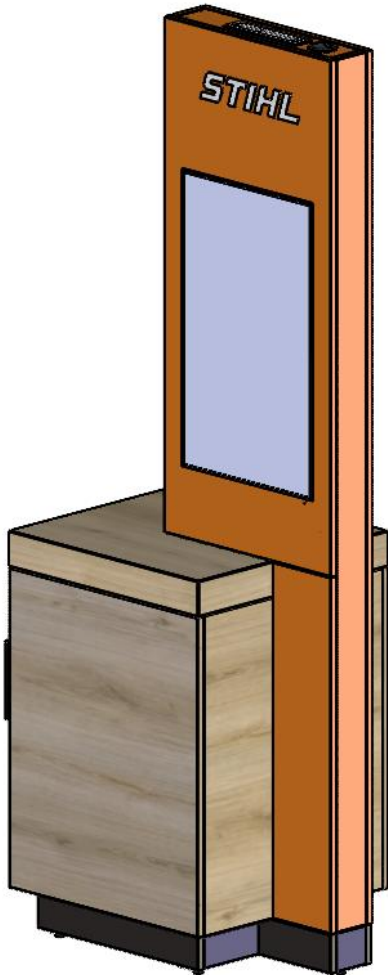

0463-595-7010®

1 pallet, 56 kg



0463-595-7012®

1 pallet, 55 kg



0463-595-7013®



1 pallet, 125 kg



Configuration options

0463-595-7010; 0463-595-7012; 0463-595-7013

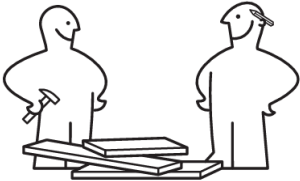
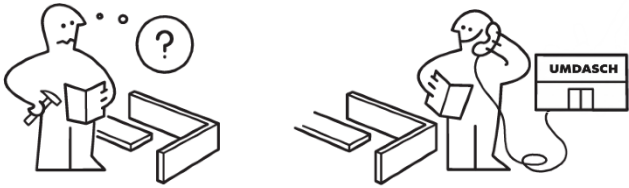
STIHL[®]

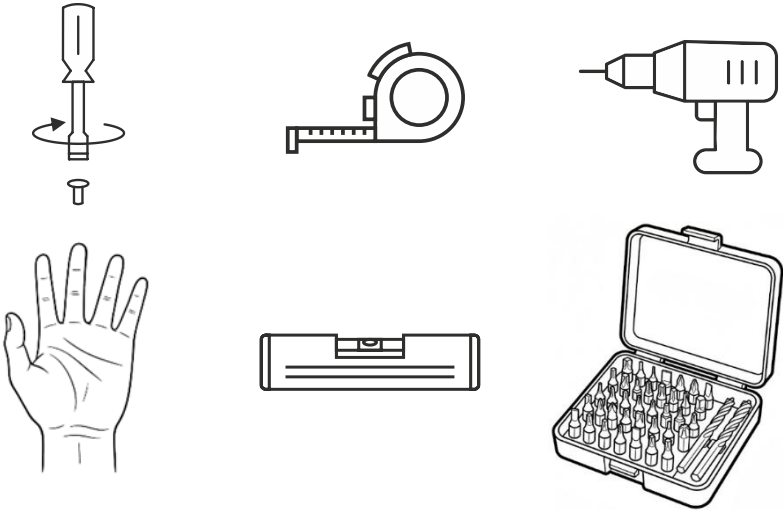
	<p>2 persons required for assembly</p>
	<p>Ivo Fryauf: ivo.fryauf@umdasch.com +420724303815</p> <p>Václav Dopita: vaclav.dopita@umdasch.com +420727861651</p>
	<p>Recommended protective equipment</p>
	<p>Tools required for assembly</p>



VARIANT [®]	PREVIEW [®]	Composition [®]
1		0463-595-7010 [®]
2		0463-595-7010 [®] 0463-595-7012 [®]



Configuration options

0463-595-7010; 0463-595-7012; 0463-595-7013

STIHL[®]

3



0463-595-7010^{*}

0463-595-7013^{*}

4



0463-595-7010^{*}

0463-595-7012^{*}

0463-595-7013^{*}



Configuration options

0463-595-7010; 0463-595-7012; 0463-595-7013

STIHL[®]

5

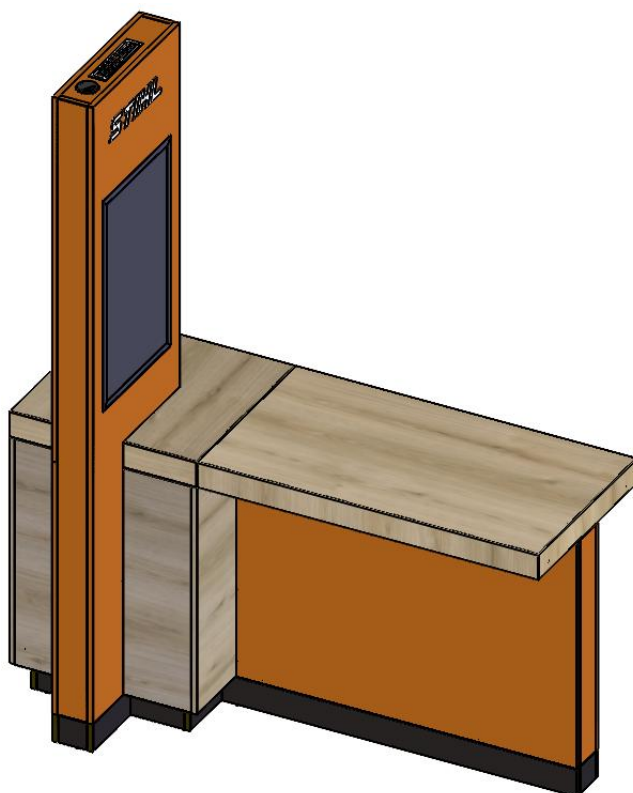

0463-595-7010^{*}

0463-595-7012^{*}

6



0463-595-7010^{*}

0463-595-7013^{*}



Configuration options

0463-595-7010; 0463-595-7012; 0463-595-7013

STIHL®

7

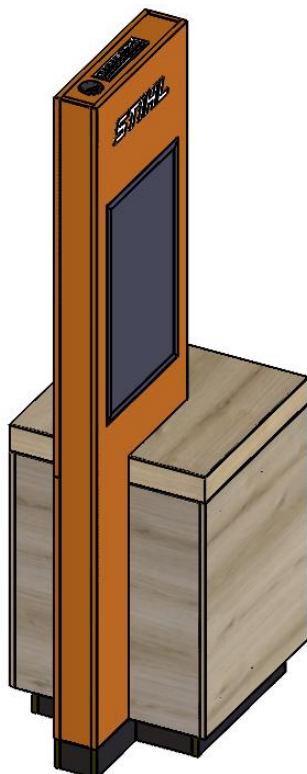

0463-595-7010*

8

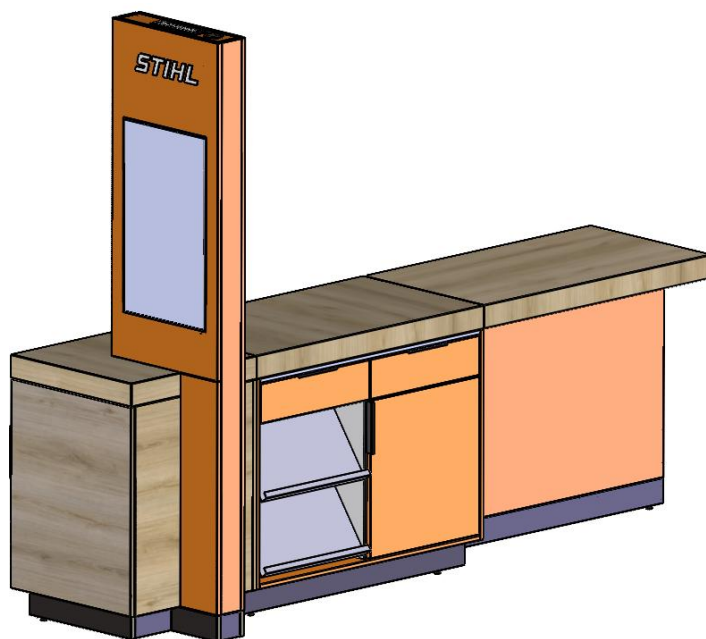

0463-595-7010*

0463-595-7012*

0463-595-7013*



VARIANT 1[®]

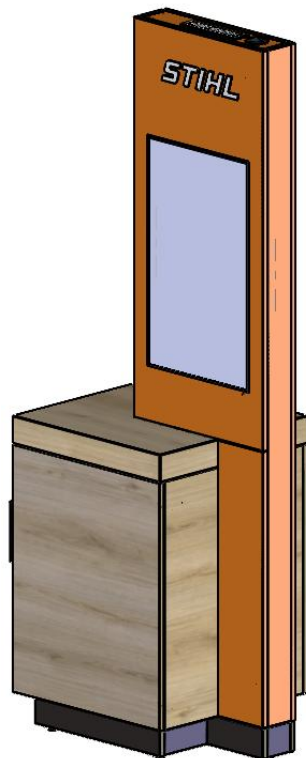

Use wood screws for the connection

4x30 DIN 7997 – 4 pcs

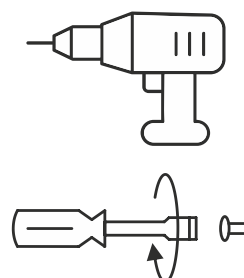
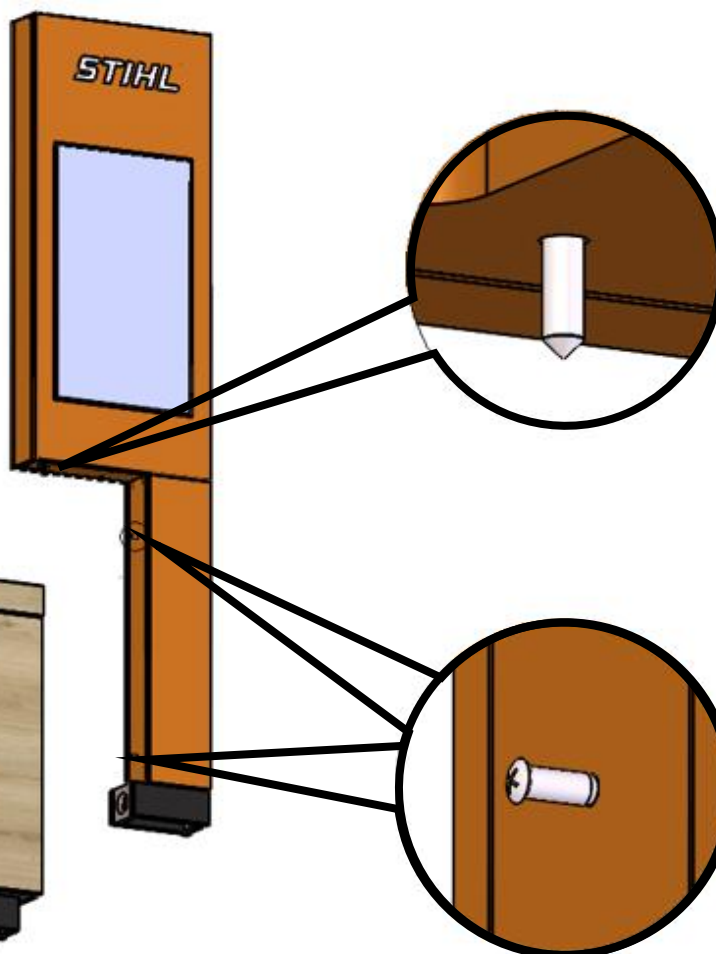

The holes are pre-drilled (not countersunk) and need to be drilled through.

To drill the holes through, you need to use an 8 mm drill bit.

Screw M6x30-40 (co. Démos)



VARIANT 2[®]

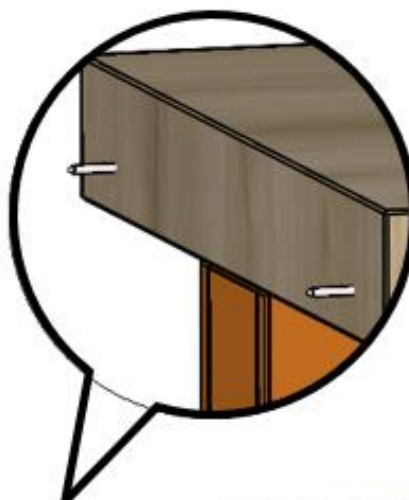
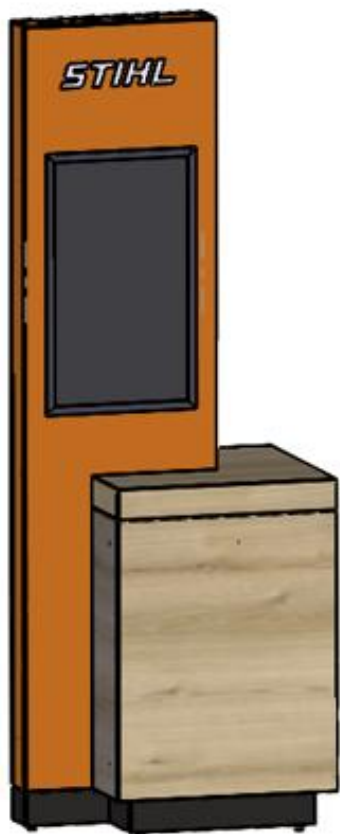
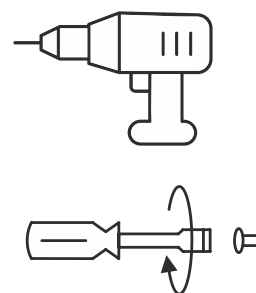

To drill the holes for the screws, use a 6 mm drill bit.

Use wood screws for the connection

5x50 DIN 7997 – 2 pcs

VARIANT 3[®]

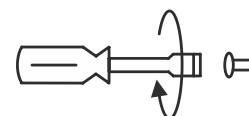
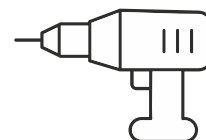

The holes are pre-drilled (not countersunk) and need to be drilled through.

To drill the holes through, you need to use an 8 mm drill bit.

Screw M6x30-40 (co. Démos)

VARIANT 4[®]

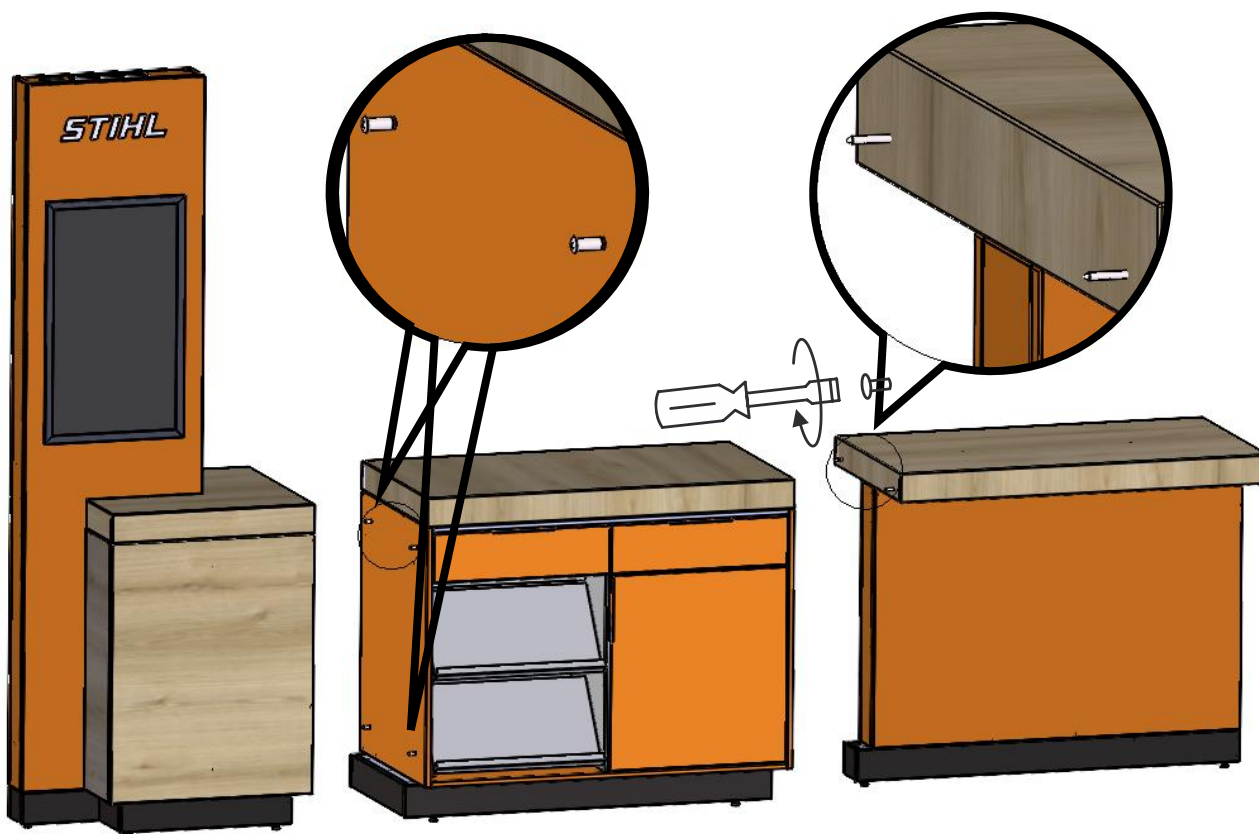

VARIANT 5[®]

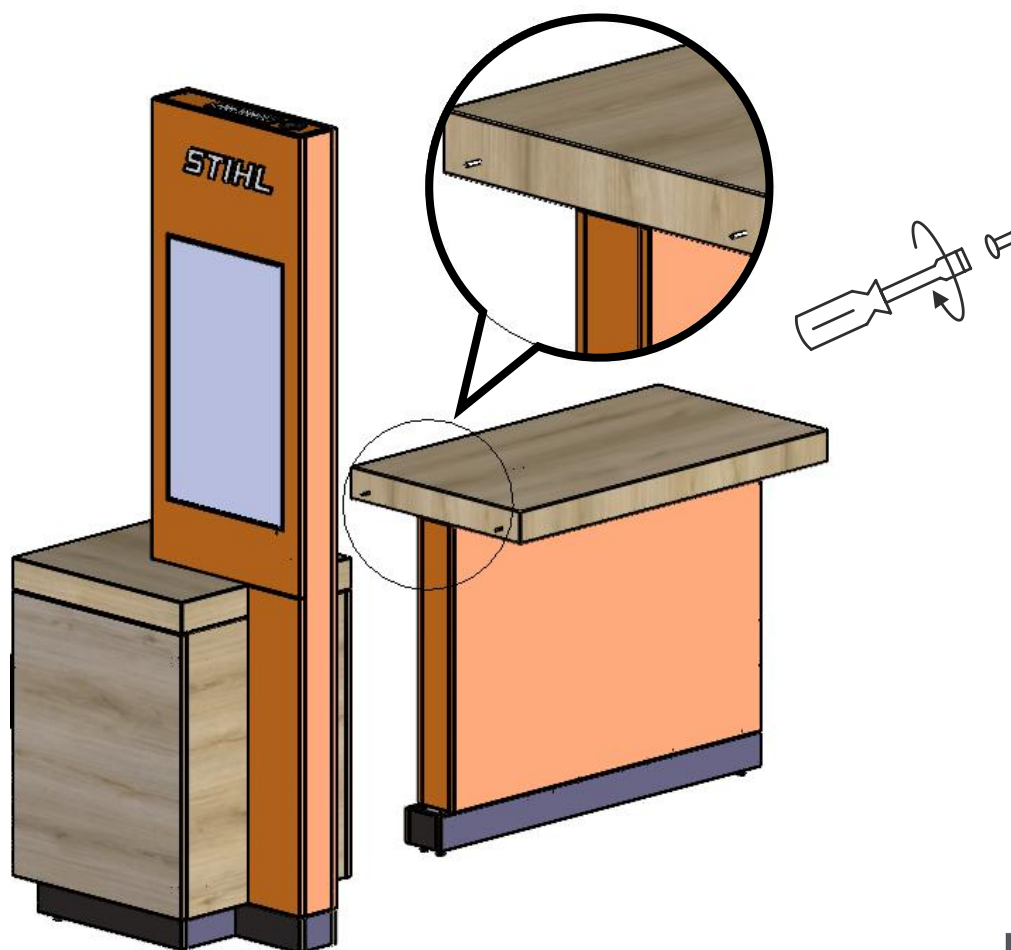
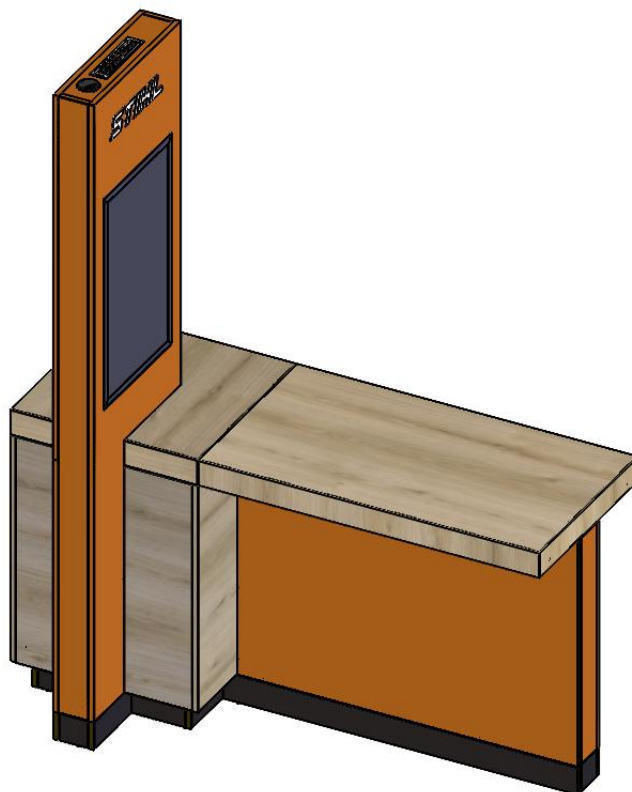

VARIANT 6[®]

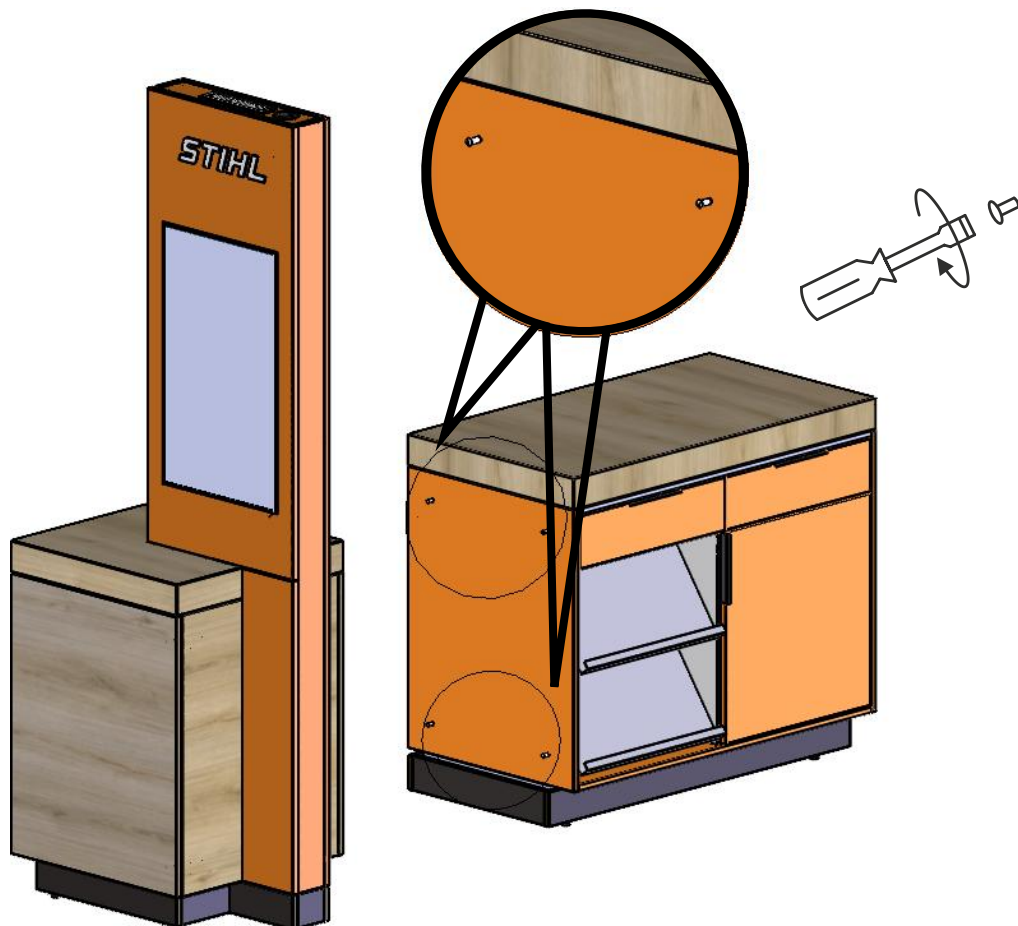
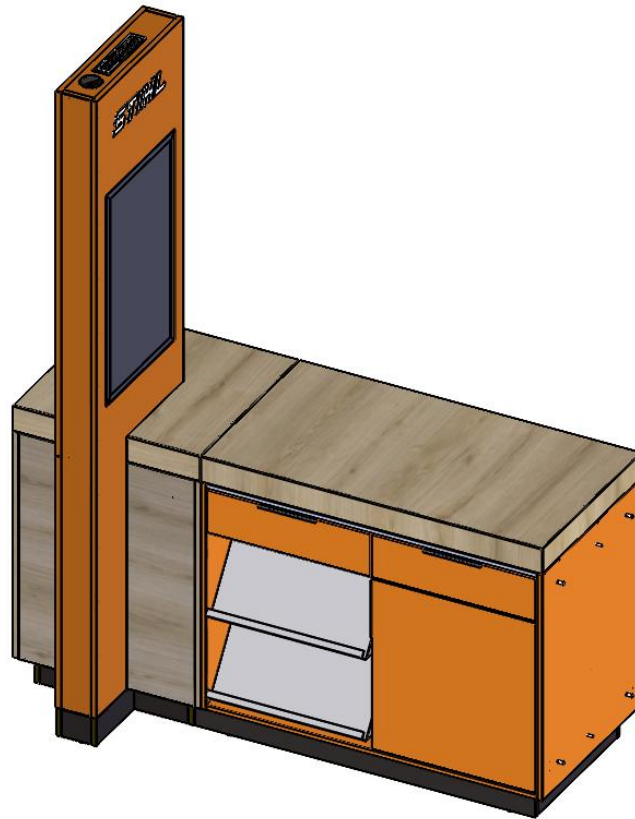

VARIANT 7[®]

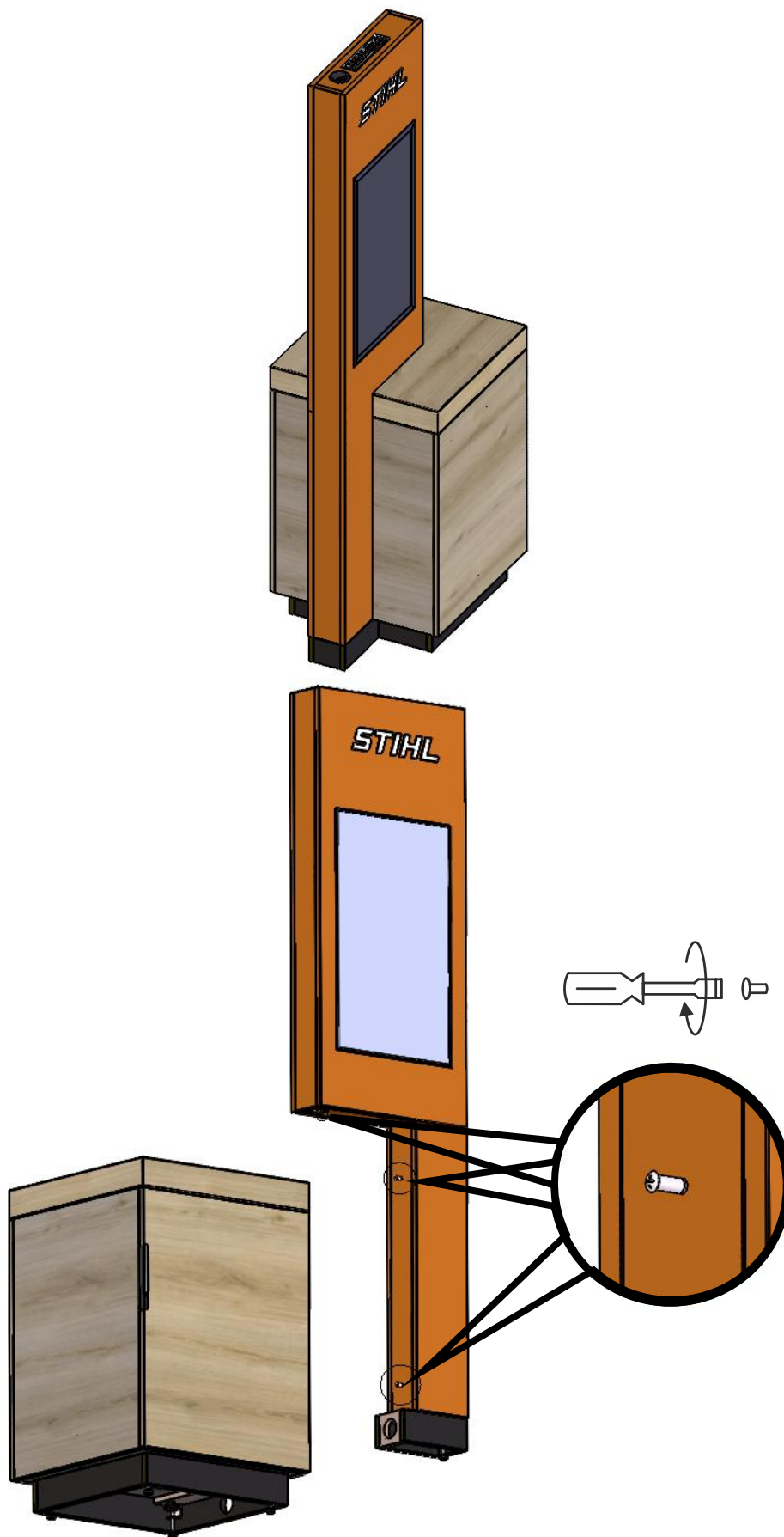

VARIANT 8[®]

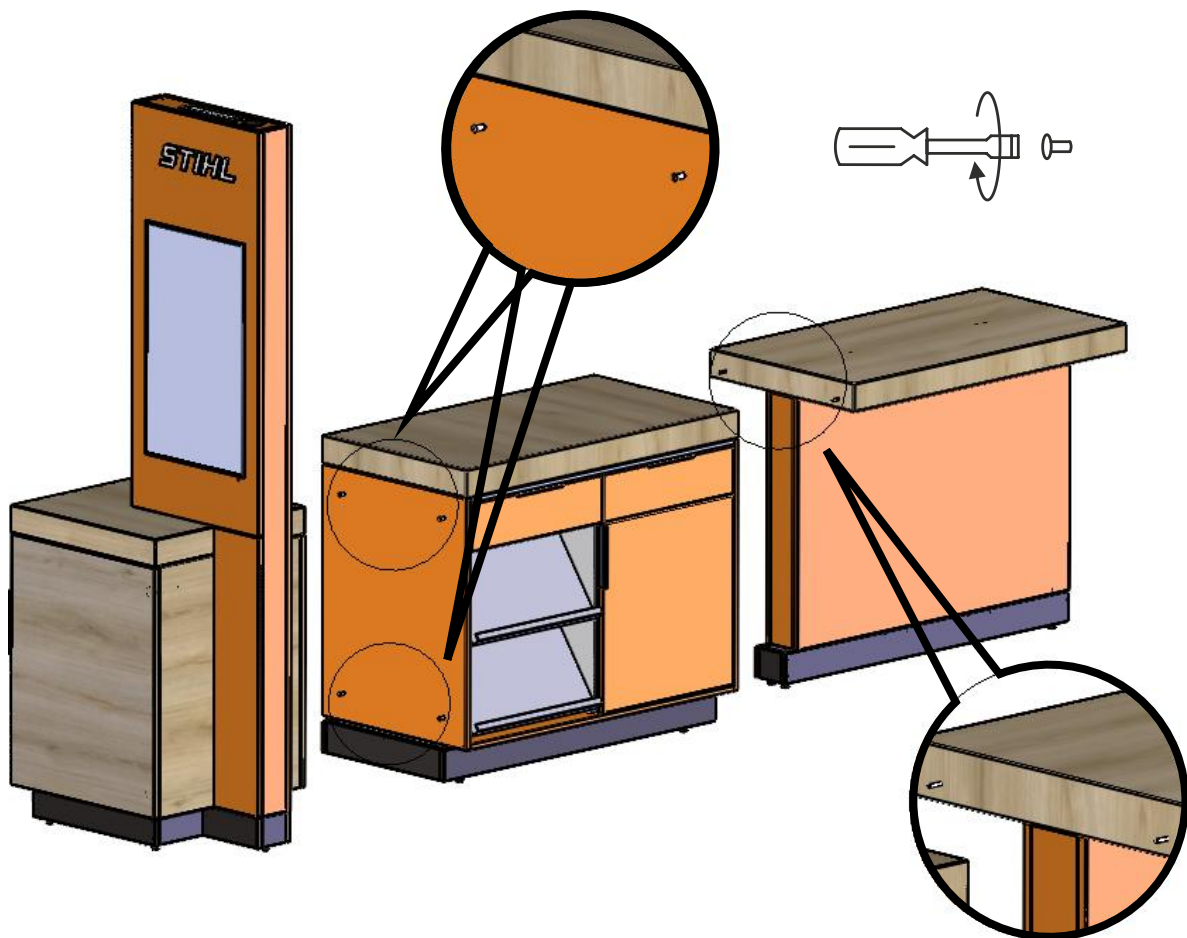
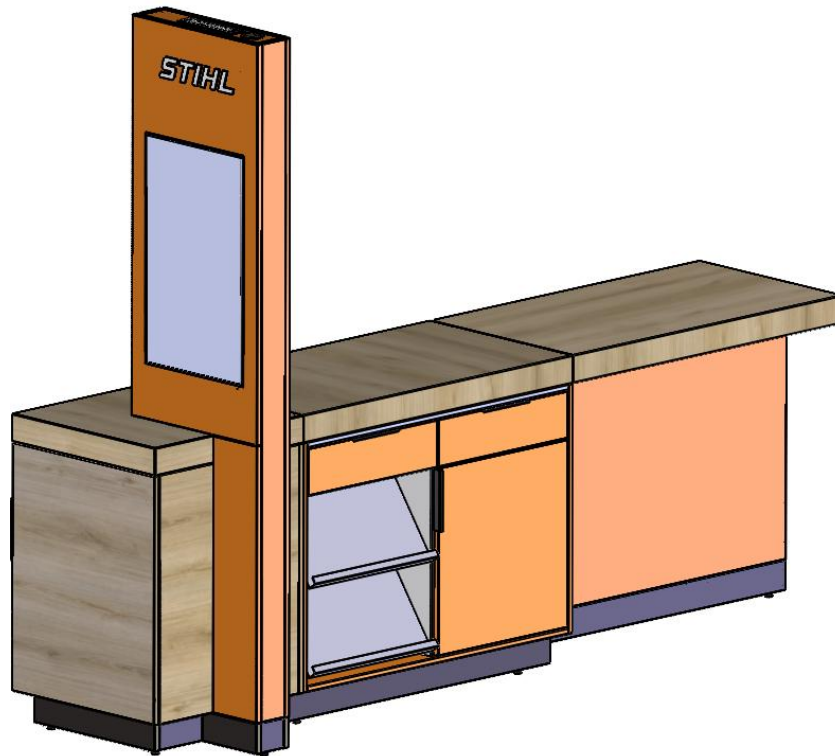

Configuration options

0463-595-7010; 0463-595-7012; 0463-595-7013

STIHL[®]



We make successful stores.

umdasch Story Design s.r.o.,

umdasch Story Design a.s. Moravská 949, 57001 Litomyšl, Czechia

www.umdasch.com | [A company of Umdasch Group](#)

